

THE EFFECT OF THE CUTTING SPEED ON THE CUTTING FORCES AND SURFACE FINISH WHEN MILLING CHROMIUM 210 Cr12 STEEL HARDFACINGS WITH UNCOATED CUTTING TOOLS

VPLIV HITROSTI REZANJA NA SILE REZANJA IN KVALITETO POVRŠINE PRI REZKANJU KROMOVH NAVAROV 210 Cr12 Z REZILNIM ORODJEM BREZ PREVLEKE

Abdullah Altin

Van Vocational School of Higher Education, Yuzuncu Yıl University, 65080 Van, Turkey
aaltin@yyu.edu.tr

Prejem rokopisa – received: 2013-06-25; sprejem za objavo – accepted for publication: 2013-07-12

The experimental study presented in this paper aims to select the most suitable cutting and offset parameter combination for a milling process in order to obtain the desired surface roughness value for a machined workpiece of chromium 210 Cr12 steel, in terms of cutting speed, feed rate and depth of cut for the milling process. A series of experiments was performed on chromium material with a cutting width of 50 mm using a round, uncoated, cemented-carbide insert on a engine power 5.5 kW Jhonford VMC550 CNC vertical machining center without any cutting fluid. The experiments were carried out using four different cutting speeds ((70, 90, 110, 130) m/min) at a constant depth of cut (1 mm) and feed rate (0.3 mm/r) and the effects of the cutting speeds on the primary cutting force and the surface roughness were investigated. The cutting force (F_c) and the surface roughness (R_a) decreased with the workpiece material's easy machinability. From the experiments, the highest average primary cutting force was obtained as 658.17 N at a cutting speed of 70 m/min. The lowest average surface roughness was 0.36 μm , which was obtained at a cutting speed of 70 m/min. The experimental results indicated that the obtained chip form is narrow and short stepped.

Keywords: machinability, uncoated cemented-carbide insert, cutting speed, cutting force, surface roughness

Namen predstavljene študije je izbira najprimernejših parametrov rezanja, hitrosti rezanja, hitrosti podajanja in globine reza pri rezkanju in kombinacije parametrov pri postopku rezkanja za doseganje zelene hrapavosti površine obdelovancev iz kromovega jekla 210 Cr12. Izvršena je bila serija preizkusov rezanja širine 50 mm na kromovem materialu z vložki iz karbidne trdine brez prevleke na CNC vertikalnem obdelovalnem centru Jhonford VMC550 moči 5,5 kW in brez hladilne tekočine za rezanje. Preizkusi so bili izvršeni pri štirih hitrostih rezanja ((70, 90, 110, 130) m/min) pri konstantni globini rezanja (1 mm) in hitrosti podajanja (0,3 mm/r). Preiskovan je bil vpliv hitrosti rezanja na primarno silo rezanja in hrapavost površine. Sila rezanja (F_c) in hrapavost površine (R_a) sta se zmanjševali z lažjo obdelovalnostjo obdelovanca. Preizkusi so pokazali, da je povprečje največje sile rezanja 658,17 N pri hitrosti rezanja 70 m/min. Povprečje najmanjše hrapavosti površine 0,36 μm je bilo doseženo pri hitrosti rezanja 70 m/min. Rezultati preizkusov so pokazali, da so dobjeni ostružki ravni in kratko stopničasti.

Ključne besede: obdelovalnost, vložki iz karbidne trdine brez prevleke, hitrost rezanja, sila rezanja, hrapavost površine

1 INTRODUCTION

High-chromium steel belongs to the group of corrosion-resistant materials and this leads to its practical applications.¹ High-chromium hardfacing materials are widely used in industry due to their excellent wear resistance.² The wear resistance of these materials was mainly achieved by a high hardness and a high carbide content, and this makes the machining of these hardfacings extremely difficult.³ There is a widespread need for abrasion-resistant materials in industries as diverse as mining and food processing.^{2,4} The productivity of machining operations can be expanded and the quality of products can be improved by using higher cutting speeds than are traditionally applied. Developments in cutting tools, work materials and machine tools have resulted in the spread of high-speed cutting technology.⁵ The development of ultra-hard CBN materials has opened up the possibility to machine these materials by turning or

milling instead of grinding, thus improving the productivity and reducing the cost.⁶ Chip formation is one of the most important aspects of the cutting process, with a factor such as tool wear being related to the behaviour of the workpiece material around the cutting edge.⁷ The formation mechanism of the chip depends on the thermal properties and the metallurgical state of the workpiece material, as well as on the dynamics of the machine's structure and the cutting process.⁸ The chip-formation process of hardfacing and the tool-wear characteristics were previously investigated.⁹ This paper further reports on a measurement of the cutting forces and the surface roughness to predict the machining quality of hardfacings at different cutting speeds, which is another key factor in the machinability of chromium steel 210 Cr12 materials. The cutting forces generated during a machining operation are mainly influenced by the properties of the workpiece and the tool material, the machining parameters used and other condition, e.g., the coolant.

Factors such as tool wear, surface quality and chip formation, etc., are all affected by the cutting temperature. In many cases the temperature was a limiting factor for the cutting-tool efficiency.^{7,8,10} When cutting some very hard materials using ceramic tools, e.g., case-hardened alloy steel and superalloys, sufficient cutting heat is needed to soften the workpiece material.¹¹⁻¹³ Extensive research work has been done to investigate the machining process of these high-chromium hardfacing materials.^{14,15}

2 MATERIALS AND METHOD

2.1 Experimental Specimens

The workpiece material was chromium steel 210 Cr12 with the chemical composition shown in **Table 1**. The machining tests were performed by the single-point milling of this material in flat form with dimension of 100 mm × 50 mm × 30 mm. The milling machine had a continuously variable spindle speed of up to 10000 m/min with a maximum power of 5.5 kW. The mechanical properties and Typical EDS analyses of the specimens are given in **Table 2** and **Figure 1**. The morphology of the surface is given in **Figure 2**.

Table 1: Chemical composition of the workpiece material (chromium steel 210 Cr12), w/%

Tabela 1: Kemijska sestava materiala obdelovanja (kromovo jeklo 210 Cr12), w/%

C	Si	Mn	P	S	Cr	Cu	Mo	Ni
2.08	0.28	0.39	0.017	0.012	11.48	0.15	0.02	0.31

2.2 Cutting parameters, cutting tool and tool holder

The milling tests were conducted with uncoated cemented-carbide cutting tools. No coolant was used during the tests. The tools were commercial-grade inserts with the geometry *RPHX1204MOEN*. Four different cutting speeds were selected, i.e., 70 m/min, 90 m/min,

110 m/min and 130 m/min, while the cutting parameters, feed rate and depth of cut were kept fixed at 0.30 mm/r and 1 mm. The cutting speeds were chosen by taking into consideration the recommendations of the manufacturing companies. In this study the purpose was to investigate the surface roughness and the material quality on the main cutting force, taking into account the cutting speed. Surtrasonic 3-P measuring equipment was used for the measurements of the surface roughness. The cutting diameter was 50 mm and the cutting width was 30 mm. The experiments were carried out with a 90° lead-angle milling cutter and only one cutting insert was used in the milling cutter. The used tool geometry was as follows: rake angle 0°, clearance angle 7°.

A regression and variance analysis was applied during the experimental study.

Table 2: Mechanical properties of chromium steel 210 Cr12

Tabela 2: Mehanske lastnosti kromovega jekla 210 Cr12

Temperature of annealing <i>T</i> /°C	Cooling	Hardness HB
800–850	At stove	Max. 250
Hardening °C	Environment	Hardness, after hardening (HRC)
930–960	Weather, lubricant or hot bath 400–450 °C	63–65

2.3 Machine-Tool and Dynamometer type

The milling tests were carried out under orthogonal cutting conditions on a Jhonford VMC550 CNC vertical machining center without any cutting fluid, with a max. power of 5.5 kW and a max. revolution number of 10,000 r/min. During the dry cutting process, a Kistler brand 9257 B-type three-component piezoelectric dynamometer under a tool holder with the appropriate load amplifier is used to measure the three orthogonal cutting forces (F_x , F_y , F_z) acting on the cutting tool in the X, Y, Z directions, data-acquisition software. This allows direct and continuous recording and a simultaneous graphical

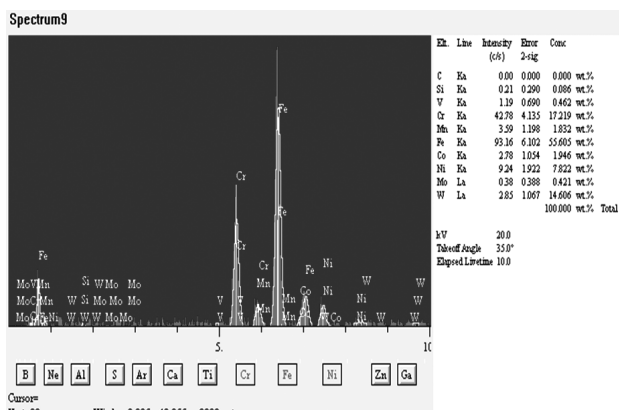

Figure 1: Typical EDS analysis of the mechanical workpiece material chromium 210 Cr12 steel

Slika 1: Značilna EDS-analiza obdelovanja iz kromovega jekla 210 Cr12

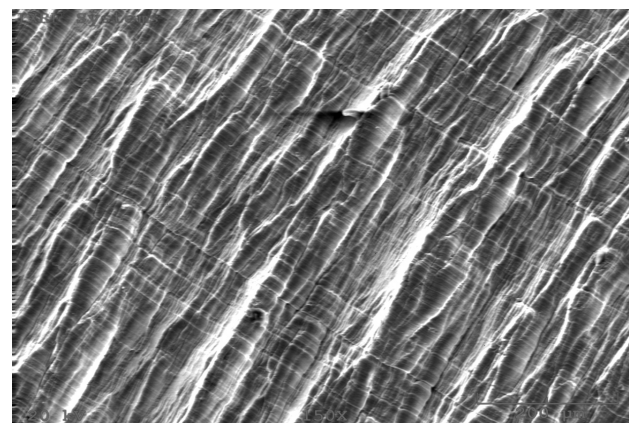

Figure 2: Morphology of surface of the chromium 210 Cr12 steel (SEM)

Slika 2: Značilnosti površine kromovega jekla 210 Cr12 (SEM)

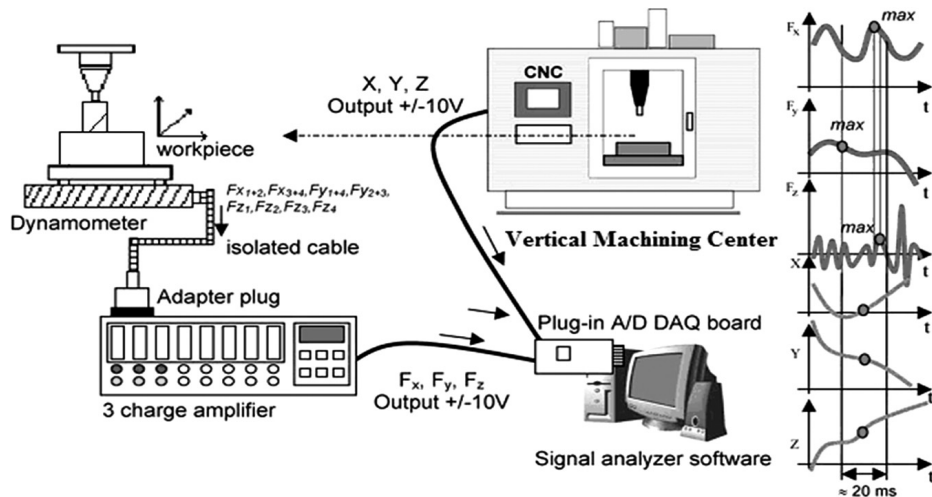

Figure 3: System architecture: left: schematic system scheme; right: data sampled and recorded, each record is composed by 12 values $[(F_{xmax}, F_y, F_z), (F_x, F_{ymax}, F_z), (F_x, F_y, F_{zmax}), x, y, z]$

Slika 3: Zgradba sistema: levo: shematski prikaz sistema; desno: zapis zbranih podatkov; vsak zapis sestoji iz 12 vrednosti $[(F_{xmax}, F_y, F_z), (F_x, F_{ymax}, F_z), (F_x, F_y, F_{zmax}), x, y, z]$

visualization of the three orthogonal cutting forces. The technical properties of the dynamometer and the schematic diagram of the experimental setup are given in **Table 3** and **Figure 3**. Reference system (F_x, F_y) fixed to the cutting tool in the rotating dynamometer and milling process under orthogonal cutting conditions are given in **Figure 4**. Surtrasonic 3-P measuring equipment is used for the measurement of the surface roughness. The measurement processes are carried out with three replications. For measuring the surface roughness on the workpiece during machining, the cut-off sampling lengths are considered as 0.8 mm and 2.5 mm. The ambient temperature is $(20 \pm 1)^\circ\text{C}$. The resultant cutting force was calculated to evaluate the machining performance. The reference system (f_x, f_y) was fixed to the cutting tool, in the rotating dynamometer. In this study, the technical properties of dynamometer and the general specifications of the CNC vertical machining center used in the experiments are given in **Tables 3** and **4**. The levels of the independent variables are shown in **Table 5**. The results of the regression and variance analysis in the models are given in **Tables 6** and **7**.

3 RESULTS AND DISCUSSION

3.1 Cutting forces and surface roughness

In this work the aim was to define the variation of the cutting forces related to the cutting speed and the alteration experimentally in order to investigate the effects of the cutting parameters on the surface roughness in the milling process for the chromium steel material. The experiments were successfully carried out and practical results for the milling process were obtained. The main cutting force changed, depending on the cutting speed and the uncoated material of the cutting tool, and while the depth of cut and the feed rate were constant, the cutting speed was changed in all the experiments.

The main cutting-force values with respect to the cutting speed are given in **Figure 5**. The lowest main cutting force of 212 N is observed at a cutting speed of 110 m/min. **Figure 5** indicates that increasing the cutting speed decreases the main cutting force, excluding the area between 110 m/min and 130 m/min. The obtained main cutting-force values at the cutting speeds of 70 m/min, 90 m/min, 110 m/min and 130 m/min are 244 N, 236 N, 212 N and 231 N, respectively. The results of **Figure 5** show that the cutting speed must be increased in order to reduce the main cutting forces.¹⁶ However, in this study, a decrease is observed in the main cutting force between 70 m/min and 110 m/min. It is considered that this case is caused by plastic deformation, flank edge, crater and notch wear, which are formed at the cutting tool because of the high temperatures of the shear area when using uncoated carbide tools that have a low

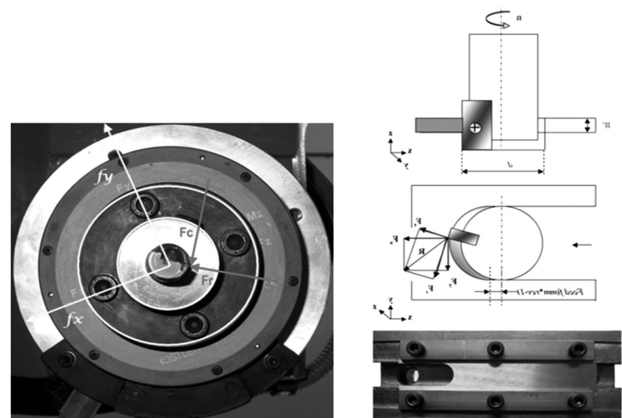

Figure 4: Reference system (F_x, F_y) fixed to the cutting tool in the rotating dynamometer and milling process under orthogonal cutting conditions

Slika 4: Referenčni sistem (F_x, F_y) , pritrjen na orodje za rezanje v rotacijskem dinamometru in postopek rezkanja v razmerah ortogonalnega rezanja

density at high cutting speeds. The effect of uncoated carbide inserts was found to be important on the main cutting force, but the effect of the cutting speeds was not important in the analysis of variance.¹⁷ The main cutting force increases in spite of increasing the cutting speed at 130 m/min. As a result of an increase of 85.7 % in the cutting speed (130 m/min), while working at low cutting speeds (70 m/min) a decrease of 13.1 % was found in the main cutting force. The high temperature in the flow region and the decreasing contact surface area caused the main cutting force to decrease in comparison to the increased cutting speed. The decrement of the cutting force depends on the material type, the working conditions and the cutting-speed range. It was found that by increasing the cutting speed from 110 m/min to 130 m/min, the main cutting force increases by 9.4 %. Since the rake angle changes due to breakage of the cutting tool, a decrease of the main cutting force in spite of increasing the cutting speed can be attributed to the tool wear. Tool breakage affects the rake angle negatively, which causes an increase of the main cutting force. High temperature in the flow region and a decrease of the contact area and the chip thickness cause the cutting force to decrease depending on the cutting speed. The material properties, working conditions and cutting speed all affect the cutting-force decrement¹⁸. As a result of the experimental data (Figure 4), the main cutting force decrement of 13.1% with an increasing cutting speed of 42.85 % is observed at 110 m/min. The scatter plot between the surface roughness and the cutting speed, as shown in Figure 6, indicated that there is linear relationship between the surface roughness and the cutting speed. The results of Figure 6 show that the average surface roughness increases by 61.1 % with an increasing cutting speed from 70 m/min to 130 m/min. The average surface-roughness values were found to be (0.36, 0.365, 0.425 and 0.58) μm for cutting speeds of (70, 90, 110, and 130) m/min, respectively. As is widely known, the cutting speed must decrease to improve the average surface roughness.¹⁹ According to the round-type insert, the change of the three axes cutting forces and chip for-

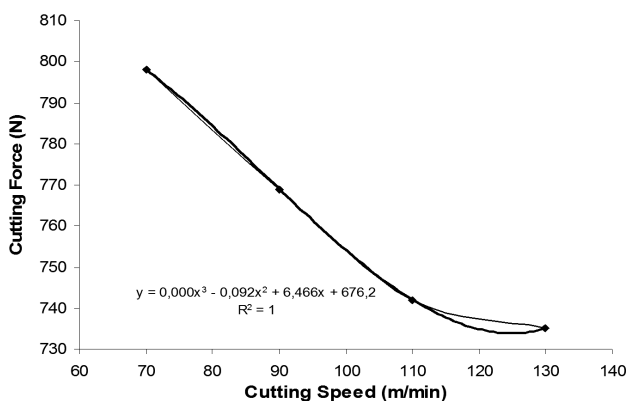

Figure 5: Cutting force ($F_{x,max}$) values (N) with respect to the cutting speeds at a constant feed rate

Slika 5: Vrednosti sile rezanja ($F_{x,max}$) v (N) glede na hitrosti rezanja pri konstantni hitrosti podajanja

mation at $V = 90$ m/min are given in Figure 7. The most remarkable result concluded from Figure 7 is that the main cutting force was decreased in the 110 m/min, the opposite direction of the rake angle, for all cutting speeds, while the cutting force was decreased by increasing the rake angle in a positive direction. This is due to changing the tool/chip contact area. The change of the main cutting force depends on the cutting speed and the uncoating material of the cutting tool. After the prepared test specimens were cut for experimental purposes, they were measured with a three-component piezoelectric dynamometer to obtain the main cutting force. Cemented-carbide tools for the cutting of the chromium steel show a low performance at high cutting speeds.²⁰ In this study, since chromium steel is used, the cemented-carbide tools showed a weaker performance.⁹ The results of this experimental study can be summarized as follows: increasing cutting speed by 85.7 %, (70–130 m/min) causes the main cutting force to decrease by 13.1 %, and increasing the cutting speed by 57.1 % causes the main cutting force to decrease by 13.75 %. The minimum main cutting force value of 212 N was obtained at a cutting speed of 110 m/min. The experimental results indicated that the obtained chip form is narrow and short stepped. Chip formation at $V = 90$ m/min are shown in Figure 8.

Table 3: Technical properties of the dynamometer

Tabela 3: Tehnične značilnosti dinamometra

Force interval (F_x, F_y, F_z)	-5 kN 10 kN
Reaction	< 0.01 N
Accuracy F_x, F_y	≈ 7.5 pC/N
Accuracy F_z	≈ 3.5 pC/N
Natural frequency $f_0(x,y,z)$	3.5 kHz
Working temperature	0 °C70 °C
Capacitance	220 pF
Insulation resistance at 20 °C	> 1013 Ω
Grounding insulation	> 108 Ω
Mass	7.3 kg

Table 4: General specifications of the CNC vertical machining center used in the experiments

Tabela 4: Osnovne značilnosti uporabljenega CNC vertikalnega obdelovalnega centra

Model	CNC FANUC 0-M Y.O.M. 1998
Travel X, Y, Z	500 mm \times 450 mm \times 450 mm
Table Dimensions	705 mm \times 450 mm
Tool Changer	18 tools
SPIRSIN	Divisor with tiltable axis
Phase number	3
Frequency	50 Hz
Max revolution number	10000 r/min

Figure 6 clearly shows the effect of feed rate, cutting speed and cutting-tool material on the average surface roughness. According to this figure, in order to obtain the smallest surface roughness, it is necessary to use the RPHX1204MOEN cutting tool at low feed rate (0.30 mm/r) and low cutting speed (70 m/min). In addition, in

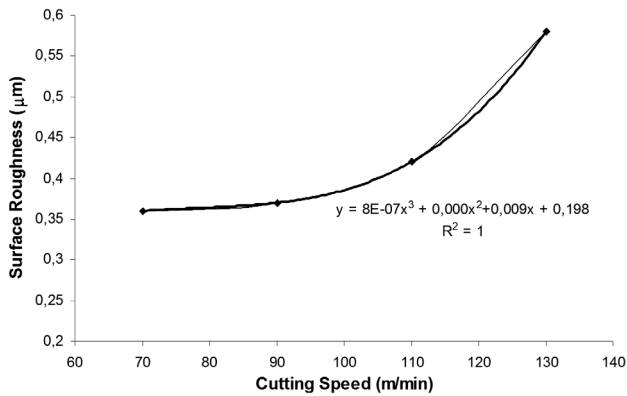

Figure 6: Surface-roughness values (μm) with respect to the cutting speeds at a constant feed rate

Slika 6: Vrednosti za površinsko hrapavost (μm) glede na hitrost rezanja pri konstantni hitrosti podajanja

order to find out which important parameter effects the surface roughness, a variance analysis was made for this aim. According to the results of the ANOVA in **Table 7**, the most efficient cutting parameter that affected the surface roughness was found to be the tool material of the uncoated insert (81.24 %), followed by the cutting speed (4.56 %).

Table 5: Level of independent variables

Tabela 5: Nivo neodvisnih spremenljivk

Variables	Level of variables			
	Lower	Low	Medium	High
Cutting speed, v /(m/min)	70	90	110	130
Feed, f /(mm/r)	0.3	0.3	0.3	0.3
Axial depth, d_a /mm	1	1	1	1

Table 6: Regression analysis of experiment

Tabela 6: Regresijska analiza preizkusov

Regression Analysis: F_x versus V ; V_f

* V_f is highly correlated with other X variables

* V_f has been removed from the equation

The regression equation is $F_x = (870 - 1.09) V$

Predictor	Coef	SECoef	T	P
Constant	869.72	18.86	46.12	0.000
V	-1.0862	0.1840	-5.90	0.028

$S = 8.23028$ $R - S_q = 94.6\%$ $R - S_q(\text{adj}) = 91.9\%$

Source	DF	SS	MS	F	P
Regression	1	2359.9	2359.9	34.84	0.028
Residual error	2	135.5	67.7		
Total	3	2495.4			

Table 7: Variance analysis of experiment

Tabela 7: Analiza variance preizkusov

Source	D_f	Sum of Squares	Mean square	F ratio	Probability	PD
Cutting speeds	3	61906.2	20635.4	0.8436	0.5075	4.56
Uncoated insert	3	1102720.4	367573.5	15.0262	0.0012	81.24
Error	8	195697.0	24462			14.42
Total	14	1357422.4				100

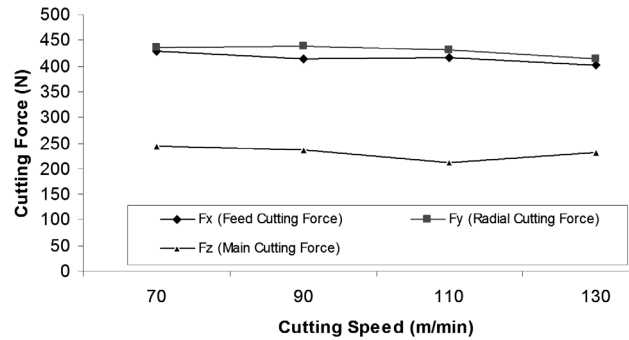

Figure 7: The change of the 3 axis cutting forces for a (1 mm) constant depth of cut and (0.3 mm/r) constant feed rate, dependent on the cutting speed (m/min)

Slika 7: Sprememba 3-osnih sil rezanja pri konstantni globini rezanja (1 mm) in konstantni hitrosti podajanja (0,3 mm/r) v odvisnosti od hitrosti rezanja (m/min)



Figure 8: Chip formation at $V = 90$ m/min

Slika 8: Oblika ostružkov pri $V = 90$ m/min

4 CONCLUSIONS

The machinability of chromium-carbide-based hard-facing appears to be strongly related to its microstructural properties, and in particular to the presence and deformation characteristic of the large carbides. The effect of cemented carbide on the main cutting force is much clearer than the effect of the cutting speed. There is an incremental-decremental relationship between the cutting speed and the main cutting force. The breaking on chip contact surface was affected by the tool rake angle in a negative way. The negative chip angle caused an increase in the main cutting force. An increasing relationship between the cutting speed and the arithmetic average surface roughness as well as between the coating

number and the average surface roughness was observed. In the case of the coated tools, the effect of the cutting speed on the surface roughness was much more pronounced than the effect of the different coated cemented-carbide inserts. The experimental results can be used in industry in order to select the most suitable parameter combination in order to achieve the required surface.

5 REFERENCES

- ¹ K. Ichii, K. Fujimura, T. Takase, Tech. Rep. Kansai Univ., 27 (1986), 135
- ² Wear Resistant Surface in Engineering: A Guide to their Production, Properties and Selection, International Research and Development Co. Ltd., Department of Trade and Industry, London, 1985
- ³ I. M. Hutchings, A. N. J. Stevenson, Wear of hardfacing white cast irons by solid particle erosion, *Wear*, 186–187 (1995), 150–158
- ⁴ R. Menon, New development in hardfacing alloys, *Weld J.* (February) (1996), 43–48
- ⁵ R. I. King (Ed.), *Handbook of high speed mach. technology*, Chapman and Hall, London 1985
- ⁶ E. J. Brookes, R. D. James, X. J. Ren, Machining of welded hardfacing materials, In: *Proceedings of the Fourth International Conference on Behavior of Materials in Machining: Opportunities and Prospects for Improved Operations*, Stratford-Upon-Avon, UK, 1998, 189–198
- ⁷ E. M. Trent, *Metal Cutting*, 3rd Edition, Butterworths, London 1991
- ⁸ D. A. Stephenson, J. S. Agapiou, *Metal Cutting Theory and Practice*, Marcel Dekker, New York 1996
- ⁹ X. J. Ren, R. D. James, E. J. Brookes, Wear characteristics of CBN tools in machining hardfacing materials, *J. Superhard Mater.*, 1 (1999), 36–45
- ¹⁰ M. C. Shaw, *Metal Cutting Principles*, Clarendon Press, Oxford 1984
- ¹¹ P. J. Heath, Structure, properties and applications of polycrystalline cubic boron nitride, In: *Proceedings of the 14th North American Manufacturing Research Conference*, Minneapolis, MN, USA, 1986, 66–80
- ¹² A. M. Abrao, D. K. Aspinwall, M. L. H. Wise, A review of polycrystalline cubic boron nitride cutting tool developments and application, In: *Proceedings of the 13th International Matador Confer.*, Manchester, UK, 1993, 169–180
- ¹³ W. Konig, A. Berktold, J. Liermann, N. Winands, Top quality components not only by grinding, *Ind. Diamond Rev.*, 3 (1994), 127–132
- ¹⁴ R. M. Hooper, C. A. Brookes, Microstructure and wear of cubic boron nitride aggregate tools, In: *Proceedings of the Second International Conference on Science Hard Material*, Rhodes, 1984, 907–917
- ¹⁵ C. A. Brookes, R. D. James, F. Nabhani, A. R. Parry, Structure, composition, and integrity of workpiece: tool interfaces in metal cutting and grinding, In: *Proceedings of the IMechE Seminar on Tribology in Metal Cutting and Grinding*, 1992, 41–48
- ¹⁶ G. Boothroyd, *Fundamentals of metal machining and machine tools*, International Student ed. 5th Printing, McGraw-Hill, New York 1981
- ¹⁷ E. P. De Garmo, J. T. Black, R. A. Kohser, *Material and process in manufacturing*, Prentice-Hall International Inc., Englewood Cliffs, NJ 1997
- ¹⁸ C. Çakır, *Modern metal cutting principles*, VIPAS, Bursa, 2000
- ¹⁹ X. J. Ren, R. D. James, E. J. Brookes, L. Wang, Machining of high chromium hardfacing materials, *J. Mater. Process. Technol.*, 115 (2001) 3, 423–429
- ²⁰ X. J. Ren, Q. X. Yang, R. D. James, L. Wang, Cutting temperatures in hard turning chromium hardfacings with PCBN tooling, *Journal of Materials Processing Technology*, 147 (2004) 1, 38–44