

OPTICAL-FIBER COMMUNICATIONS: COMPONENTS AND SYSTEMS

Matjaž Vidmar

Faculty of Electrical Engineering, University of Ljubljana, Slovenia

INVITED PAPER

MIDEM 2001 CONFERENCE

10.10.01 - 12.10.01, Hotel Zlatorog, Bohinj

Key words: optical communications, optical fibers, components, systems, state of the art, design, limitations, capacities, optical terminals, terminal equipment

Abstract: Optical-fiber communications brought a revolution to communication technology, outperforming other communication systems by several orders of magnitude in transmission capacity, unrepeated and repeated communication range and decreasing installation and operating costs. The optical-fiber revolution started approximately 30 years ago, when technology improvements decreased the optical-fiber loss to less than 20dB/km. The theoretical loss limit for silica (SiO₂) based fibers was reached only 10 years later, but the fiber handling and line-terminal technology was far from mature at that time. Even with primitive line-terminal technology, optical fibers immediately outplaced coaxial-cable systems and decreased the importance of microwave and satellite point-to-point radio links. In the last two decades, significant improvements have been made in the line-terminal technology, including narrow-spectrum solid-state lasers, wide-bandwidth modulators, laser optical amplifiers, fast and sensitive photodetectors and last but not least, high speed electronics. Although advanced laboratory experiments are quickly approaching the theoretical capacity offered by the > 10 THz bandwidth of a single-mode optical fiber, several problems have yet to be solved to make high-capacity systems viable, including linear and nonlinear propagation effects in the optical fiber itself, high performance electro/optical and opto/electric converters, efficient high speed electronics and all-optical signal-processing components. The purpose of this presentation is to summarize the present status of optical-fiber communication technology, to discuss the basic components and the limitations of these devices, and to present the requirements and proposals for future systems.

Komunikacije po optičnih vlaknih : Gradniki in sistemi

Ključne besede: komunikacije optične, vlakna optična, komponente, sistemi, stanje razvoja, snovanje, omejitve, kapacitete, terminali optični, oprema terminalna

Izvelek: Zveze po optičnih vlaknih so prinesle revolucijo v tehnologijo telekomunikacij, saj omogočajo za več velikostnih razredov večjo zmogljivost, večji domet brez in z regeneracijo ter nižje nabavne in obratovalne stroške. Revolucija optičnih vlaken se je začela pred približno 30 leti, ko so izboljšave tehnologije znižale slabljenje optičnega vlakna pod 20dB/km. Teoretska meja slabljenja za vlakna iz kremenovega stekla (SiO₂) je bila dosežena že 10 let kasneje, toda rokovanje z vlakni in terminalna oprema sta bila zelo daleč od zrelosti v tistih časih. Celo s preprosto terminalno opremo so optična vlakna takoj zamenjala sisteme s koaksialnimi kablji in zmanjšala pomen mikrovalovnih in satelitskih zvez točka-točka. V zadnjih dveh desetletjih se je tehnologija terminalne opreme bistveno izboljšala, vključujoč ozkopasovne polprevodniške laserje, širokopasovne modulatorje, laserske optične ojačevalnike, hitre in občutljive fotodetektorje in nenazadnje hitro elektroniko. Čeprav se vrhunski laboratorijski poskusi hitro približujejo teoretski meji, ki jo omogoča pasovna širina > 10THz enorodovnega optičnega vlakna, številna vprašanja okoli praktične uvedbe visokozmogljivih sistemov ostajajo odprta, vključujoč linearna in nelinearna popačenja prenosne poti po optičnem vlaknu, visokozmogljive elektrooptične in optično/električne pretvornike, učinkovito hitro elektroniko in gradnike za vseoptično obdelavo signalov. Namen te predstavitve je prikazati sedanje stanje komunikacij po optičnih vlaknih, razložiti osnovne gradnike in njihove omejitve ter prikazati zahteve in predloge za bodoče sisteme.

1. Optical fiber design

Optical fibers are members of a much broader group of dielectrical waveguides. Dielectrical waveguides potentially offer wide bandwidths and low insertion loss due to the absence of metals and related ohmic losses. Although the principles of operation of dielectric waveguides were known for a long time, practical low-loss optical fibers were only manufactured three decades ago.

The design of a low-loss, high-capacity optical fiber is shown on figure 1. The main dielectric material is pure silica (SiO₂) glass. Some germanium oxide is added to the core to raise its refraction index to allow the operation as a waveguide. The dimensions of the cladding (125µm) and

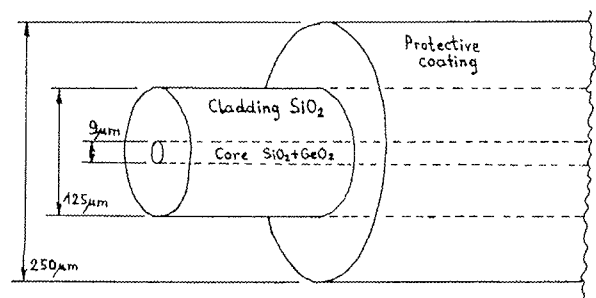

Figure 1: Optical fiber construction.

protective coating (250µm) are standardized to allow interconnections among products from different manufacturers. The diameter and refraction index of the core are care-

fully selected for the required numerical aperture (NA) and single-mode operation at the desired optical wavelength.

The attenuation of a silica-based optical fiber is shown on figure 2. While the impurity content can be reduced by better manufacturing techniques and UV absorption only plays a secondary role, the attenuation of a silica-based optical fiber is mainly determined by the Rayleigh scattering and IR absorption. Silica fibers achieve their minimum insertion loss of about 0.2dB/km at optical wavelengths of around 1.55um (194THz).

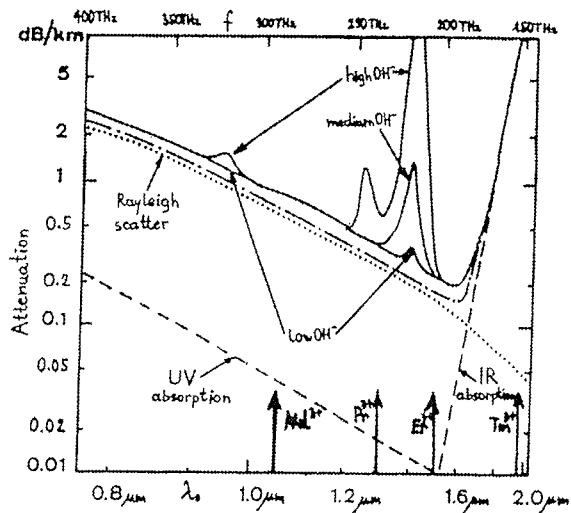

Figure 2: Optical fiber attenuation.

The attenuation of optical fibers is several orders of magnitude lower than competing metal cables, while their bandwidth is several orders of magnitude larger due to the carrier frequency in the optical region. Optical fibers therefore have several potential advantages over competing technologies.

2. Optical fiber limitations

Silica optical fibers also have a few limitations. Low-loss fibers achieve a low numerical aperture (NA around 0.1). The core size of single-mode optical fibers is very small (10um). It is therefore particularly difficult to couple light into an optical fiber as shown on figure 3. A large degree of spatial coherence is required from the light source.

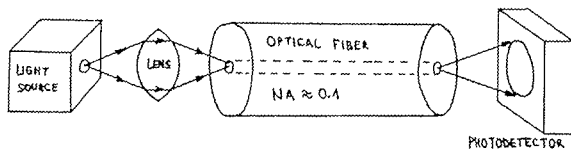

Figure 3: Light source and photodetector coupling.

Semiconductor lasers are usually used to achieve a high coupling efficiency of around 50% and a launched power up to a few hundred milliwatts into a singlemode fiber. Light-

emitting diodes can also be used, but due to their incoherent nature, the coupled optical power into the fiber is very small, only a few microwatts into a singlemode fiber. The performance of optical-fiber links may be already limited by the insufficient power launched into the fiber as in the case of incoherent (LED) transmitters.

When a high coupling efficiency is obtained and sufficient light power is launched into a singlemode fiber, other effects may limit the link performance as shown on figure 4. When using broadband sources like (longitudinal) multimode, Fabry-Perot semiconductor lasers, the link performance may be limited by linear chromatic dispersion. Such links usually operate around 1.3um, where the linear chromatic dispersion is minimal for conventional singlemode fibers.

- (A) Linear chromatic dispersion:

$$\Delta t = D_\lambda \cdot \Delta \lambda \cdot L$$

$$D_\lambda = -\frac{\omega^2}{2\pi c_0} \cdot \frac{d^2 n}{d\omega^2}$$
- (B) Nonlinear refraction coefficient (Kerr effect):

$$n(P) = n_0 + n_2 \cdot \frac{P}{A_{eff}}$$

$$A_{eff} \approx 80 \mu m^2$$

$$n_2 \approx 3.2 \cdot 10^{-20} m^2/W$$
- (C) Raman and Brillouin scattering:
 Raman: mainly forward, $B \approx 4 THz$, $\Delta f \approx 13 THz$, $P_t \approx 300 mW$
 Brillouin: backward, $B \approx 10 MHz$, $\Delta f \approx 116 GHz$, $P_t \approx 3 mW$
- (D) Polarization mode dispersion:

$$\Delta t = D_p \cdot \sqrt{L}$$

$$D_p = 0.1 \dots 2 ps/\sqrt{km}$$

Figure 4: Propagation effects in optical fibers.

The optical power launched into a singlemode fiber is limited by different nonlinear effects including Raman and Brillouin scattering and the Kerr effect. The threshold power for the Brillouin scattering may be very low, but fortunately the latter is a narrowband effect. Raman scattering and the Kerr effect both limit the maximum signal power in a singlemode fiber to a few hundred milliwatts.

In the case linear chromatic dispersion is perfectly compensated and the signal power is kept low enough, the optical-fiber link performance may be limited by polarization mode dispersion. Polarisation mode dispersion is caused by small differences in the propagation velocities of the two orthogonally polarized, degenerated modes in a rotationally-symmetrical singlemode fiber. Unfortunately, high-birefringence, polarisation maintaining fibers are not practical for long-distance links for many reasons.

3. Optical fiber capacity

The capacity of a communication link depends on the available bandwidth and signal-to-noise ratio. In optical fiber communications, both optical (quantum) noise and electronics (thermal) noise are present. The noise spectral density for both noise types is shown on figure 5. Quantum noise is part of the optical signal and is further increased by the amplified spontaneous emission of optical amplifiers. Thermal noise is the main limitation in all terminal equipment electronics.

Noise power: $P_n = B \cdot N_0$

Thermal noise density: $N_0 = k \cdot T$ (Rayleigh-Jeans)
 $k = 1.38 \cdot 10^{-23} \text{ J/K}$ (Boltzmann)

Quantum noise density: $N_0 = h \cdot f$
 $h = 6.624 \cdot 10^{-34} \text{ J}\cdot\text{s}$ (Planck)

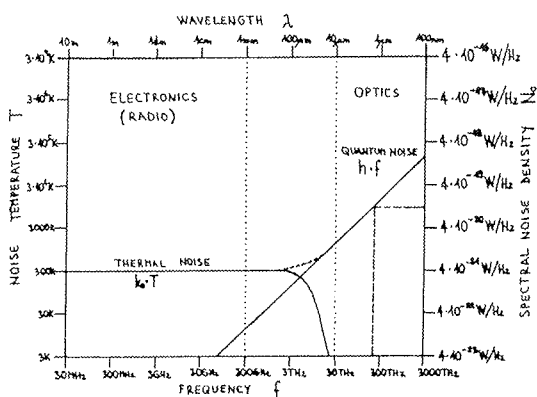

Figure 5: Electrical and optical noise.

In the case of a simple optical receiver as shown on figure 6, the predominant noise source is the thermal noise of the following electrical amplifier, in spite of the good quantum efficiency of a PIN photodiode. In such a simple receiver, electrical (thermal) noise is about 20dB stronger

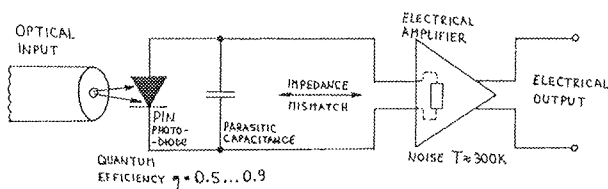

Figure 6: Noise in a simple optical receiver.

than optical (quantum) noise. In other words, while the quantum limit for a single logical "1" is 21 photons for a bit-error rate of 1.0E-9, a real receiver requires about 2000 photons for a logical "1" for the same bit-error rate. The main cause of the poor receiver performance is a large impedance mismatch between the photodiode and following electrical amplifier, further complicated by the always present parasitic capacitance.

The performance of optical-fiber links can be much improved by optical laser amplifiers. The best performance is currently achieved by erbium-doped fiber amplifiers as shown on figure 7. Erbium-doped fiber amplifiers may approach the quantum-noise limit to a few tenths of a dB. Like any laser amplifier, erbium-doped fiber amplifiers are bi-directional and require expensive optical isolators at both input and output.

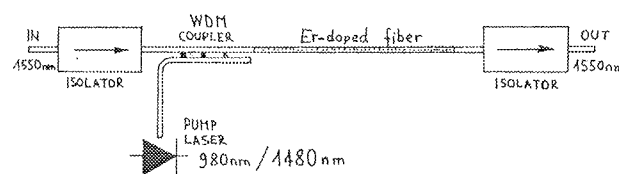

Figure 7: Erbium-doped fiber amplifier.

Before estimating the capacity of an optical-fiber link, the modulation coding loss should be estimated first. In the case of a simple optical link using intensity modulation and direct detection (IM-DD), the modulation coding loss is around -20.2dB as shown on figure 8. More efficient modulation schemes are very difficult to implement at optical carrier frequencies and the high data rates involved.

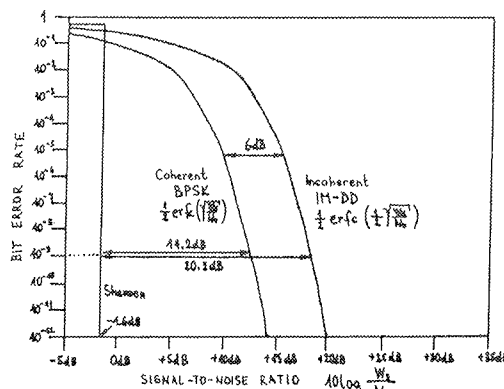
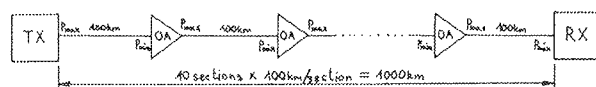

Figure 8: Simple modulation coding loss.

An estimation of the capacity of a high performance optical-fiber link covering 1000km is shown on figure 9. The link includes several erbium-doped amplifiers (usable bandwidth around 4THz) but there are no signal regenerators. The overall capacity of around 2.6Tbit/s is comparable to the bandwidth of the erbium-doped fiber amplifiers.



$B = 4 \text{ THz}$ (Er amp)
 Coding loss = $-20.2 \text{ dB} = \alpha$
 $10 \text{ sections} \rightarrow N_0 + 10 \text{ dB} = N_0'$
 $P_{max} = 100 \text{ mW} = +20 \text{ dBm}$
 $P_{min} = 0.3 \text{ mW} = -5 \text{ dBm}$

$$C = B \cdot \log_2 \left(1 + \frac{\alpha \cdot P_{min}}{B \cdot N_0'} \right) = 2.6 \text{ Tbit/s}$$

Figure 9: Optical-fiber link capacity.

4. Terminal equipment design

Although still developing, the manufacturing of optical fibers is a relatively mature technology at least for silica fibers. There are only small improvements trying to tailor the linear chromatic dispersion, increase the core effective area to reduce the nonlinear effects and improve the fiber symmetry to reduce the polarisation mode dispersion.

There are many more open issues in the design of line terminal equipment for optical-fiber communications. First, line terminal equipment should consider all of the limitations of the optical-fiber transmission path to fully utilize its capabilities. Second, due to the high data rates and wide bandwidths there are several technological constraints in designing the line terminal equipment itself.

Practically speaking, signal multiplexing from multiple sources is required both in the electrical domain as well as in the optical domain as shown on figure 10. Time-division multiplexing is used almost exclusively in the electrical domain with the rare exception of analog transmissions. Electrical time-division multiplexing is limited to about 40Gbit/s with the current semiconductor technology.

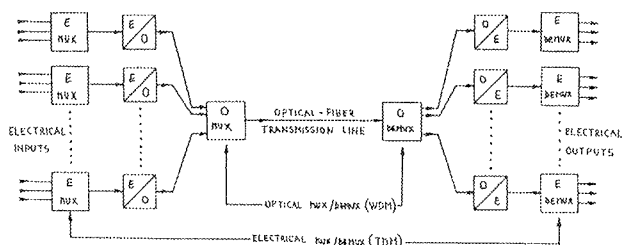

Figure 10: Electrical and optical multiplexing.

Although this figure may rise in the future, various propagation effects in the optical fiber, in particular linear chromatic dispersion and polarisation mode dispersion, also limit the maximum data rate for time-division multiplexing. In order to further increase the capacity of the optical transmission path, wavelength (frequency) division multiplexing has to be used in the optical domain.

The design of a high-capacity optical transmitter is shown on figure 11. The input electrical data is first processed in

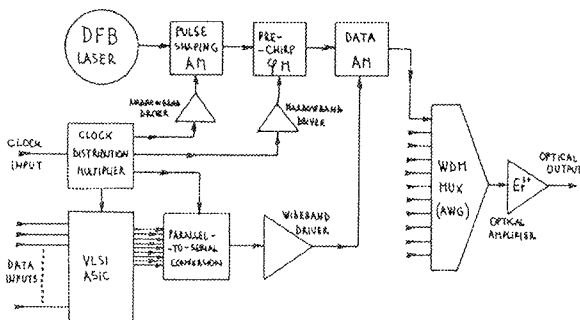

Figure 11: High-performance optical transmitter.

parallel form in a (silicon) VLSI ASIC, providing data formatting, framing and forward error correction if required. The data stream is then converted to serial form in a high-speed GaAs or InP circuit. Of course, the transmitter includes clock distribution and multiplication circuits.

The optical signal source is usually a distributed feedback laser oscillating on a single longitudinal mode with a spectral linewidth of a few ten MHz. The laser feeds a chain of several different modulators. Although simple intensity (amplitude) modulation is used for transmitting data, the optical transmission path may require pulse shaping with an additional amplitude modulator as well as pulse prechirping with a phase modulator.

Many different technologies are used to build electro-optical modulators, but the most popular designs are based on lithium niobate (LiNbO₃) interferometric modulators and on electroabsorption modulators built in semiconductor chips. Most modulator designs are polarisation dependent and require high-power and wide-bandwidth electrical drivers.

The outputs of several optical transmitters operating on different wavelengths can be combined together on a single optical fiber in a WDM multiplexer (a linear, passive combining network operating at optical frequencies). Finally, the optical signal power of all channels combined together is boosted with a single erbium-doped fiber amplifier.

Of course, a reverse signal processing has to be performed in a high-capacity optical receiver as shown on figure 12. The input optical signal level is first boosted with an optical amplifier before being fed to a WDM DEMUX (a bank of optical bandpass filters). Each signal wavelength is fed to a PIN photodiode, followed by a low-noise, wideband amplifier feeding the clock recovery and electrical demultiplexing circuits. High-capacity optical receivers may include an adaptive polarisation mode dispersion compensation.

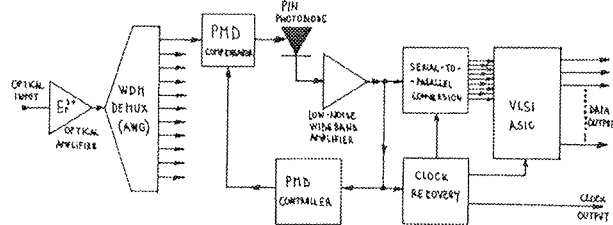
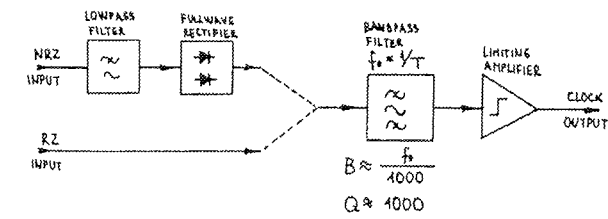
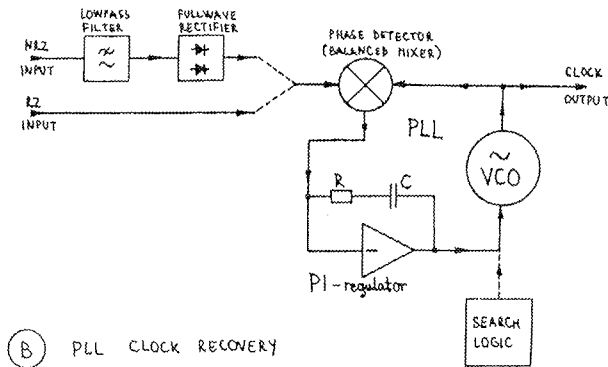

Figure 12: High-performance optical receiver.

One of the most critical functions of high-capacity receivers is the clock recovery, since it is responsible for jitter system. Electrical clock-recovery designs are shown on figure 13. In the case of a NRZ transmission, some signal processing (full-wave rectifier) is required to obtain a discrete spectral line at the clock frequency. Of course, little if any processing is required in the case of a RZ (soliton) transmission.



(A) BANDPASS-FILTER CLOCK RECOVERY



(B) PLL CLOCK RECOVERY

Figure 13: Electrical clock-recovery designs.

A bandpass filter is required to extract the clock line from the signal. A simple cavity filter as shown on figure 13A is not a very practical solution, since a high Q is required for the cavity. A PLL clock recovery as shown on figure 13B allows many more degrees of freedom including a second-order feedback network that keeps the static phase error independent of the clock-frequency offset. On the other hand, a PLL clock recovery usually requires a search logic to acquire an initial lock on the signal.

The performance of a digital communication system can be much improved using signal regeneration. At least one signal regenerator is required in the receiver, while additional signal regenerators may be inserted in the communication path. The regenerator design and operation is shown on figure 14. Full signal regeneration requires three steps: signal amplification, limiting (2R regeneration) and relocking with a D-flip-flop (3R regeneration).

Currently most signal regenerators are built as electronic circuits, although there have been attempts to build optical 2R and 3R regenerators. An important drawback of optical WDM systems is that the signal regeneration has to be performed separately for each wavelength.

5. Conclusion

Since optical-fiber communications are an important and rapidly evolving technology, it makes sense to compare the evolution of optical communications with the evolution of

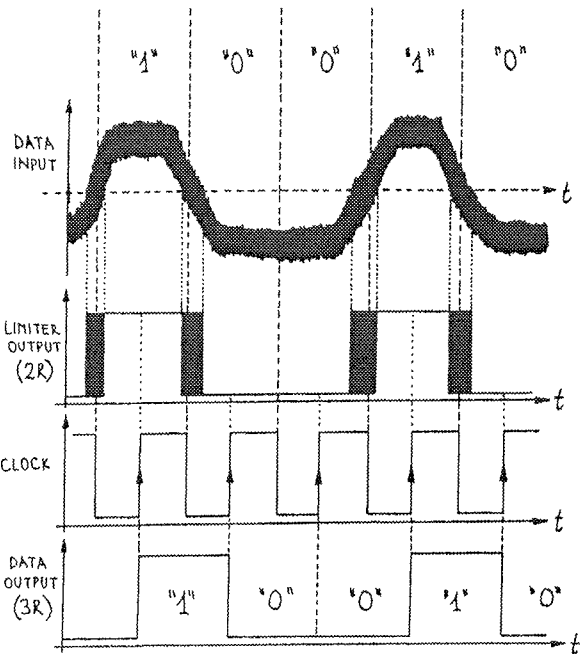
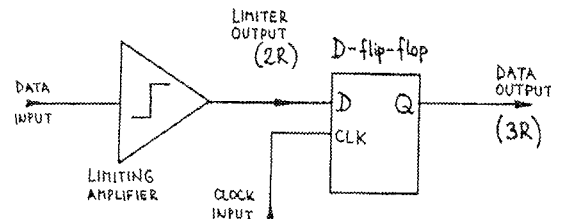

Figure 14: Regenerator design and operation.

radio communications almost one century ago. Radio started with spark-gap transmitters and rather primitive receivers. Optical-fiber communications started some 25 years ago with directly-modulated light-emitting diodes and lasers, whose optical signal spectrum was much broader than the information bandwidth just like in early radio systems.

An important breakthrough in radio communications was the vacuum-tube amplifier. The erbium-doped fiber amplifier brought a similar breakthrough to optical-fiber communications about one decade ago. Just like the vacuum-tube amplifier, the erbium-doped fiber amplifier finally allows at least some primitive signal processing in the optical domain. Unfortunately, the optical amplifier is still a complicated and expensive piece of equipment that can not be integrated easily, just like the vacuum-tube amplifier in the early days of radio communications.

The current needs of communication operators are to implement at least some low-level optical signal processing. In particular, since wavelength-division multiplexing is being used due to optical-fiber and terminal-equipment limitations, optical switching and routing is required in WDM systems as shown on figure 15. The most critical components, high-performance switching matrices, wavelength converters and optical 3R regenerators are still at a very early stage of development.

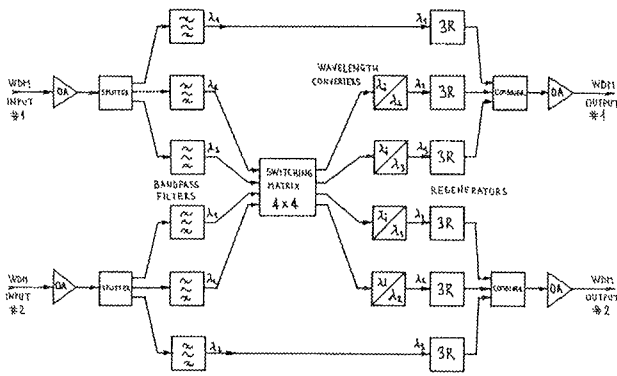

Figure 15: Optical switching and routing

At this point it is difficult to estimate the future developments of optical communication technology simply because the most important component, a simple unidirectional amplifier, like the transistor for radio frequencies, has not yet been invented for optical frequencies. All laser amplifiers

are bidirectional amplifiers and require external isolators that can not be integrated easily. Finally, the linear dimensions of optical waveguides are two orders of magnitude larger than electrical interconnections inside modern integrated circuits.

Matjaž Vidmar
 Faculty of Electrical Engineering,
 University of Ljubljana, 1000 Ljubljana,
 Tržaška 25, Slovenia

Prispelo (Arrived): 10.09.01

Sprejeto (Accepted): 01.10.01