

NUMERICAL MODEL OF A COMPOSITE AIRFOIL SEGMENT WITH PIEZOELECTRIC SENSORS

NUMERIČNI MODEL KOMPOZITNEGA ODSEKA LETALSKEGA KRILA S PIEZOELEKTRIČNIMI SENZORJI

Jan Bartošek¹, Tomáš Kroupa¹, Luboš Smolík²

¹European Centre of Excellence NTIS – New Technologies for Information Society, Faculty of Applied Sciences, University of West Bohemia, Univerzitní 22, 306 14, Pilsen, Czech Republic

²University of West Bohemia, Department of Mechanics, Univerzitní 22, 306 14, Pilsen, Czech Republic
bartose4@kme.zcu.cz

Prejem rokopisa – received: 2013-10-01; sprejem za objavo – accepted for publication: 2013-12-17

A numerical model of an airfoil segment with piezoelectric sensors was created with commercial finite-element software Abaqus and its response to impact loading was compared with experimental results. The wing segment was made of woven-glass/epoxy composite with a varying number of plies and different types of weave. The material properties were experimentally determined from the tensile tests and used in the finite-element model of a rectangular plate. The results of the experimental modal analysis of a composite rectangular plate made of the same material as the segment were compared to the results of the numerical analysis and the parameters of the numerical model were adjusted. Finally, a numerical model of the whole segment was created and validated on the basis of the results of the corresponding experimental modal analysis. Moreover, piezoelectric sensors were glued to the segment and their response to dynamic loading was compared to the results of the numerical simulation.

Keywords: glass-epoxy/textile composite, piezoelectricity, finite-element analysis, modal analysis

S komercialnim programom končnih elementov Abaqus je bil postavljen numerični model segmenta letalskega krila s piezoelektričnimi senzorji, njegov odziv na udarno obremenitev pa je bil primerjan z rezultati preizkusov. Segment krila je bil izdelan iz kompozita steklene volne in epoksi smole z različnim številom prekritij in vezave. Lastnosti materiala so bile eksperimentalno določene z nateznimi preizkusi in uporabljene v modelu končnih elementov pravokotne plošče. Rezultati eksperimentalne modalne analize kompozitne pravokotne plošče, izdelane iz enakega materiala kot segment, so bili primerjani z rezultati numerične analize, prilagojeni pa so bili tudi parametri numeričnega modela. Na podlagi ustrezne eksperimentalne modalne analize je bil postavljen in ocenjen numerični model celotnega segmenta. Piezoelektrični senzorji so bili prilepljeni na segment in njihov odziv na dinamične obremenitve je bil primerjan z rezultati numerične simulacije.

Ključne besede: kompozitna tkanina steklena vlakna z epoksi smolo, piezoelektrika, analiza končnih elementov, modalna analiza

1 INTRODUCTION

Composite materials are advantageously used in modern constructions, but they also have many limitations. One of them is their susceptibility to a failure caused by impact loading.¹ Moreover, such a failure inside the material can be hidden to classical visual inspections and, therefore, more complicated and expensive techniques like ultrasonic inspections have to be utilized. Alternative approaches like structural health monitoring were developed to monitor and evaluate a construction state during its life.²

Development of such methods requires numerical models of composite structures with mounted sensors for solving a new kind of problems like the optimum sensor layout.³ A numerical model of a composite airfoil segment with piezoelectric sensors was tested in this paper.

2 AIRFOIL SEGMENT

The airfoil segment analyzed in this paper was fabricated for research purposes by VZLU Technologies using resin transfer molding technology. Its geometry,

roughly described in **Figure 1**, consists of two parts, a spar and a skin panel, which are glued together. The segment is made of fiberglass laminate and epoxy resin EPIKOTE Resin MGS LR 385. Two types of fabric are used. Five layers of a plain-weave fabric with a uniform

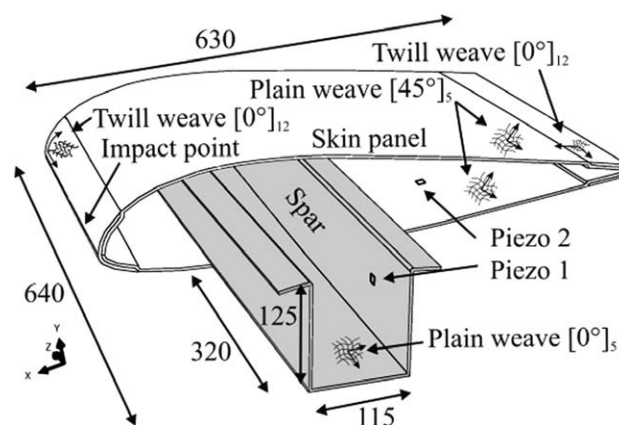

Figure 1: Geometry of an airfoil segment. All the dimensions are in mm.

Slika 1: Geometrija segmenta letalskega krila. Vse dimenzije so v mm.

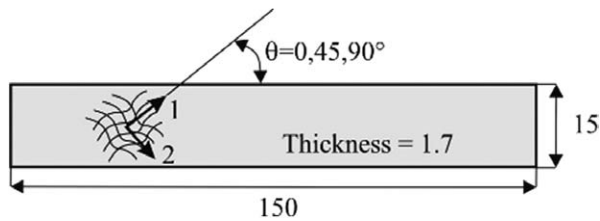

Figure 2: Geometry of a composite specimen. Dimensions are in mm.
Slika 2: Geometrija kompozitnega vzorca. Dimenzije so v mm.

orientation are used in the spar part. The skin panel consists of two parts with the same fabric layouts as used for the spar, whose borders on the leading and trailing edges are covered by twelve layers of a twill-weave fabric with a uniform orientation (**Figure 1**).

3 TENSILE TESTS

The tensile tests were performed to identify the material properties. Only the specimens from the material with the plain weave were available and the number of the layers was different from the number of the laminates used in the airfoil segment. The specimens were cut from a larger plate with a water jet with three orientations: 0°, 45° and 90° (**Figure 2**). The tensile tests were performed on a Zwick/Roell Z50 test machine and the resulting stress-strain diagrams are shown in **Figure 3**. The elastic properties of the orthotropic-lamina analytical model⁴ were chosen (**Table 1**) to fit the stress-strain curves of the experimental model (**Figure 3**).

Table 1: Elastic properties of the plain-weave lamina

Tabela 1: Elastične lastnosti ploskovne vezave

E_1 /GPa	E_2 /GPa	G_{12} /GPa	ν_{12}
16.0	20.0	3.5	0.208

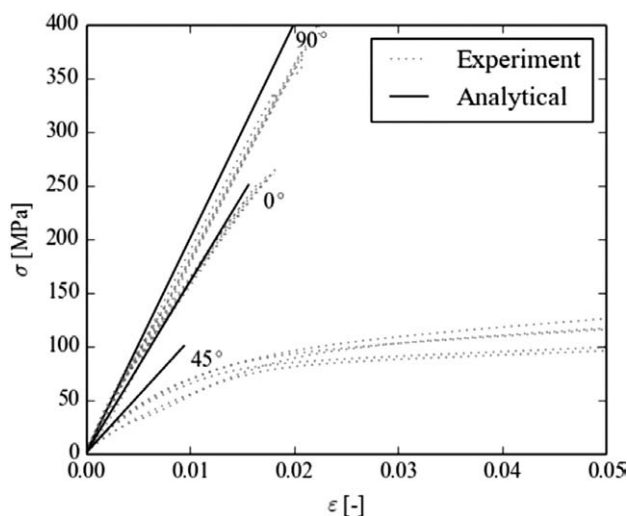

Figure 3: Stress-strain diagrams of the tensile tests
Slika 3: Diagrami napetost – raztezek iz nateznih preizkusov

4 MODAL ANALYSIS OF RECTANGULAR PLATES

Two rectangular plates (280 mm × 480 mm) made from the plain-weave ($[0^\circ]_5$ – thickness of 3.6 mm) and twill-weave fabrics ($[0^\circ]_{12}$ – thickness of 4.2 mm) with the same layout as used for the airfoil profile were manufactured and an experimental modal analysis was performed. The plates lay on flexible rubber springs to eliminate the influence of boundary conditions on natural frequencies. The plates were loaded with an impact hammer, Brüel & Kjær 8204, on a rectangular grid of 5 × 8 points and the response was measured with a triaxial accelerometer, Brüel & Kjær 4506B. A Brüel & Kjær 2827-002 analyzer with module Brüel & Kjær 3109 was used for data acquisition and software ME'ScopeVES 6 was used for an evaluation of the first ten structural natural frequencies (**Tables 2** and **3**). Several corresponding mode shapes for the material with the twill weave are shown in **Figure 4**.

Table 2: Natural frequencies of the rectangular plate with the plain weave

Tabela 2: Naravne frekvence pravokotne plošče s ploskovno vezavo

Mode	$f_{\text{Experimental}}/\text{Hz}$	$f_{\text{Numerical}}/\text{Hz}$	Error/%
1	39.94	40.21	0.7
2	50.14	50.39	0.5
3	98.82	96.75	2.1
4	139.80	138.83	0.7
5	178.10	178.55	0.3
6	189.70	186.95	1.4
7	197.10	197.94	0.4
8	275.60	281.47	2.1
9	320.40	320.13	0.1
10	447.90	461.93	3.1

Table 3: Natural frequencies of the rectangular plate with the twill weave

Tabela 3: Naravne frekvence pravokotne plošče s kepervezavo

Mode	$f_{\text{Experimental}}/\text{Hz}$	$f_{\text{Numerical}}/\text{Hz}$	Error/%
1	47.88	47.91	0.1
2	64.05	64.11	0.1
3	118.10	117.31	0.7
4	176.00	175.01	0.6
5	185.20	187.26	1.1
6	209.00	214.58	2.7
7	230.20	230.92	0.3
8	279.20	280.38	0.4
9	346.80	355.29	2.4
10	395.10	399.31	1.1

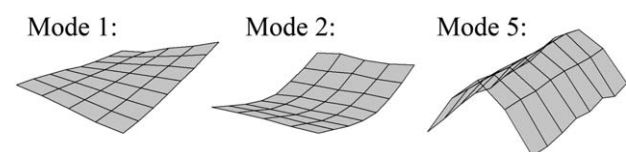

Figure 4: Measured mode shapes for the material with the twill weave
Slika 4: Izmerjene oblike materiala s kepervezavo

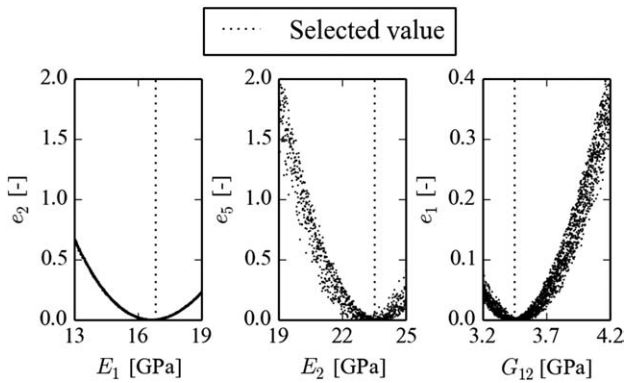

Figure 5: Influence of plain-weave-material properties on the natural-frequency error (1)

Slika 5: Vpliv materialnih lastnosti ploskovne vezave na napako naravne frekvence (1)

The corresponding numerical models were created in the finite-element software Abaqus 6.11. A linear quadrilateral shell element, type S4R, with an edge length of 10 mm and a lamina-material model with the composite layup was used.

The model creation, solver run and result evaluation were performed using command scripts written in programming language Python. This automation enabled us to run the design of the experiment in software OptiSlang to clarify the influence of mechanical parameters on natural frequencies and find the optimum values.

The variables of the design of the experiment were elastic properties of lamina E_1 , E_2 and G_{12} . The error for natural frequency i was computed as:

$$e_i = \left(\frac{f_i^{EXP} - f_i^{FEA}}{f_i^{EXP}} \right)^2 \quad (1)$$

where f_i^{EXP} is the i -th natural frequency from the experiment and f_i^{FEA} is the i -th natural frequency from the simulation. The variable space was sampled with Latin hypercube sampling into 2000 points.

The first bending natural-frequency errors (modes 2 and 5 in Figure 4) are strongly correlated with Young's

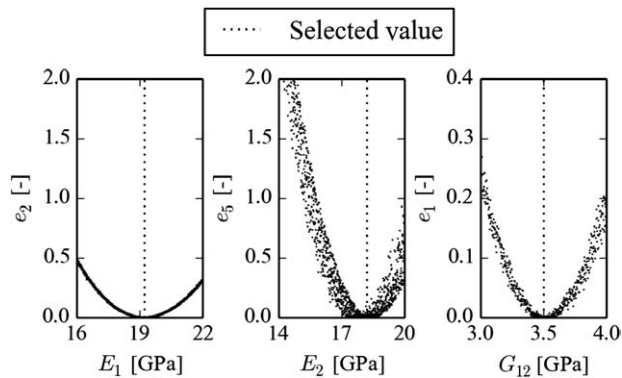

Figure 6: Influence of twill-weave-material properties on the natural-frequency error (1)

Slika 6: Vpliv materialnih lastnosti kepervezave na napako naravne frekvence (1)

modulus E_1 and E_2 , respectively, and the first torsional natural-frequency error (mode 1 in Figure 4) correlates with the shear modulus (G_{12}). Therefore, the mechanical properties of the materials were adjusted (Table 4) according to the design of the experiment (Figures 5 and 6). The natural frequencies from the numerical simulation with the adjusted material values are in Tables 2 and 3, respectively.

Table 4: Adjusted material properties (GPa)
Tabela 4: Prilagojene lastnosti materiala (GPa)

Plate with plain weave		
E_1	E_2	G_{12}
16.8	23.5	3.5
Plate with twill weave		
E_1	E_2	G_{12}
19.2	18.2	3.5

5 MODAL ANALYSIS OF THE AIRFOIL SEGMENT

An experimental modal analysis of the whole airfoil segment was performed to validate the corresponding numerical model. The segment was supported by flexible rubber springs and the experimental setup was the same as used for the experimental modal analysis of the composite plates (Figure 7). The response of the construction was measured for a total of 97 impact points and 20 natural frequencies were determined (Table 5).

The numerical model was built similarly to the models of the composite plates, with the same type of elements and the same materials. Each part of the segment was meshed individually, its connection was considered as ideal using Tie Constraint. The comparison of the natural frequencies from the experiment and the numerical simulation is shown in Table 5.

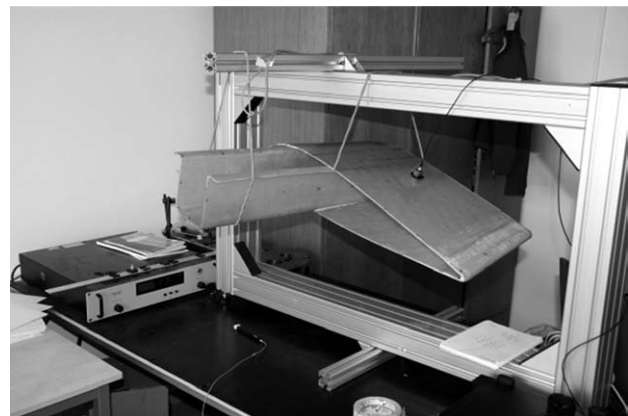

Figure 7: Experimental modal testing of the airfoil profile
Slika 7: Eksperimentalno modalno preizkušanje profila krila

Table 5: Natural frequencies of the airfoil profile

Tabela 5: Naravna frekvenca profila krila

Mode	Experimental natural freq. $f_{Exp. natur}/Hz$	Numerical natural freq. $f_{Num. natur}/Hz$	Error/%
1	59.20	59.27	0.1
2	71.00	74.75	5.3
3	87.40	87.99	0.7
4	104.00	105.28	1.2
5	110.00	109.59	0.4
6	164.00	164.40	0.2
7	179.00	176.42	1.4
8	187.00	186.80	0.1
9	190.00	198.05	4.2
10	213.00	209.06	1.8
11	226.00	228.34	1.0
12	241.00	247.55	2.7
13	250.00	250.81	0.3
14	286.00	290.30	1.5
15	309.00	311.49	0.8
16	353.00	357.46	1.3
17	360.00	359.66	0.1
18	373.00	377.26	1.1
19	376.00	382.13	1.6
20	412.00	392.52	4.7

6 TRANSIENT RESPONSE OF THE AIRFOIL SEGMENT WITH PIEZOELECTRIC SENSORS

Two piezoelectric sensors were glued to the outer surface of the airfoil segment with the HBM Z70 adhesive (Figure 1); their response to impact loading was measured and compared with the numerical model. DuraAct patch piezoelectric transducers P-876.SP1 were used as sensors. The structure was impacted with a Brüel & Kjær 8202 impact hammer and data acquisition was performed with the NI CompactDAQ measurement system with analog input modules NI 9215 and NI 9234. A synchronized measurement of the impact force and the signals from the sensors was performed with a sampling frequency of 51.2 kHz. Five impacts were measured. The signals were normalized and averaged to obtain a reference signal.

The finite-element model of the airfoil segment, used for the numerical modal analysis, was extended. Each sensor was represented by one quadratic piezoelectric hexahedron element type C3D20E to correctly approximate the electric potential field across the element.⁵ Their connection to the segment surface was considered as ideal and was realized with TIE Constraint. The electric potential degrees of freedom on the top-element surface nodes were set to be equal using Equation Constraint that simulated the electrode. The structure was loaded with the averaged reference impact-force history of the corresponding node. A transient analysis with an implicit solver and duration of 20 ms was performed. The measured impact force and the comparison

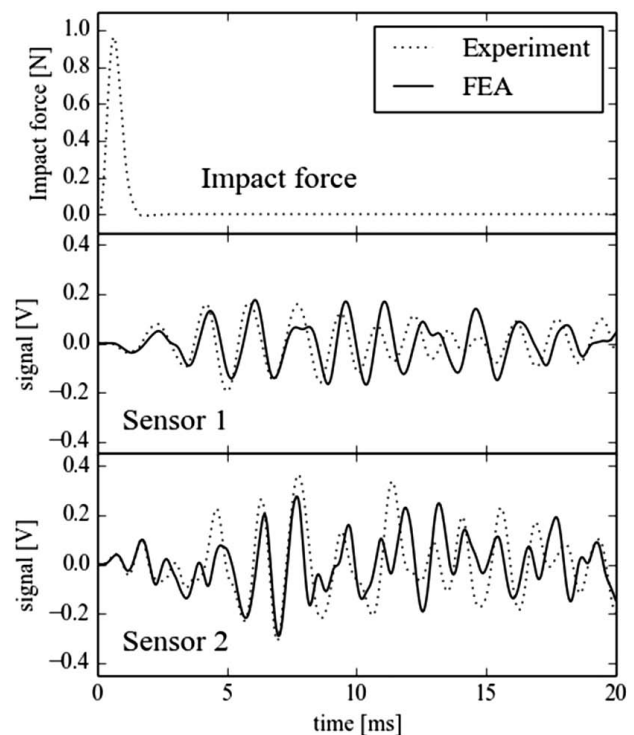

Figure 8: Measured impact force and signal response
Slika 8: Izmerjena sila udarca in signal odgovora

of the signals from the sensors for the numerical analysis and the experiment are shown in **Figure 8**.

7 CONCLUSION

A finite-element analysis of a composite airfoil segment with piezoelectric sensors was performed. The material parameters were determined with the tensile tests of thin coupons and an experimental modal analysis of a rectangular plate, whose results were compared with the equivalent analytical and numerical simulations, respectively. The difference between the determined material values was probably caused by different numbers of the plies of the tested tensile specimens and the rectangular plate.

The numerical model of the airfoil segment was built and validated with a modal analysis. A comparison of natural frequencies with the experimental data shows good agreement. The error for most of the frequencies is less than 2 % and the maximum error is 5.3 %.

A transient analysis including the piezoelectric effect was performed on the model with extended piezoelectric sensors. A comparison with the measured experimental data shows a relatively good agreement of signal characteristics. The differences were probably caused by not considering the damping effects, idealizing the glued connections and the imperfections in the segment that arose during the fabrication.

The future work will focus on improving the numerical model and applying it in further analyses, particu-

larly to find the optimum sensor layout for the impact-force identification. Piezoelectric transducers can be considered as the sensors or actuators in the current model and, therefore, a wide range of problems within the structural health monitoring can be solved.

Acknowledgement

The work was supported by the European Regional Development Fund (ERDF), project "NTIS – New Technologies for Information Society", European Centre of Excellence, CZ.1.05/1.1.00/02.0090 and the project of the Grant Agency of the Czech Republic, No. GAČR P101/11/0288.

8 REFERENCES

- ¹ M. O. W. Richardson, M. J. Wisheart, Review of low-velocity impact properties of composite materials, *Composites, Part A: Applied Science and Manufacturing*, 27 (1996) 12, 1123–1131
- ² R. Zemčík, V. Laš, T. Kroupa, J. Bartošek, Reconstruction of Impact on Textile Composite Plate Using Piezoelectric Sensors, *Proceedings of the Ninth International Workshop on Structural Health Monitoring*, Stanford, 2013, 393–400
- ³ A. Takezawa, K. Makihara, N. Kogiso, M. Kitamura, Layout optimization methodology of piezoelectric transducers in energy-recycling semi-active vibration control systems, *Journal of Sound and Vibration*, 333 (2014) 2, 327–344
- ⁴ A. E. Bogdanovich, C. M. Pastore, *Mechanics of textile and laminated composites: with applications to structural analysis*, Chapman & Hall, New York 1996
- ⁵ Z. Lašová, R. Zemčík, Comparison of Finite Element Models for Piezoelectric Materials, *Procedia Engineering*, 48 (2012), 375–380